



Bose® S1 Pro
Multi-Position PA System





Owner's Guide

Important Safety Instructions

Please read and keep all safety and use instructions.

1. Read these instructions.
2. Keep these instructions.
3. Heed all warnings.
4. Follow all instructions.
5. Do not use this apparatus near water.
6. Clean only with a dry cloth.
7. Do not block any ventilation openings. Install in accordance with the manufacturer's instructions.
8. Do not install near any heat sources such as radiators, heat registers, stoves, or other apparatus (including amplifiers) that produces heat.
9. Do not defeat the safety purpose of the polarized or grounding-type plug. A polarized plug has two blades with one wider than the other. A grounding-type plug has two blades and a third grounding prong. The wider blade or third prong is provided for your safety. If the provided plug does not fit in your outlet, consult an electrician for replacement of the obsolete outlet.
10. Protect the power cord from being walked on or pinched, particularly at plugs, convenience receptacles, and the point where it exits from the apparatus.
11. Only use attachments/accessories specified by the manufacturer.
12.  Use only with the cart, stand, tripod, bracket, or table specified by the manufacturer or sold with the apparatus. When a cart is used, use caution when moving the cart/apparatus combination to avoid injury from tip-over.
13. Unplug this apparatus during lightning storms or when unused for long periods of time.
14. Refer all servicing to qualified personnel. Servicing is required when the apparatus has been damaged in any way such as power-supply cord or plug is damaged, liquid has been spilled or objects have fallen into the apparatus, the apparatus has been exposed to rain or moisture, does not operate normally, or has been dropped.

WARNINGS/CAUTIONS:

-  This symbol on the product means there is uninsulated, dangerous voltage within the product enclosure that may present a risk of electrical shock.
-  This symbol on the product means there are important operating and maintenance instructions in this guide.
-  Contains small parts which may be a choking hazard. Not suitable for children under age 3.
-  This product contains magnetic material. Consult your physician on whether this might affect your implantable medical device.

- All Bose products must be used in accordance with local, state, federal and industry regulations. It is the installer's responsibility to ensure installation of the product is performed in accordance with all applicable codes, including local building codes and regulations. Consult the local authority having jurisdiction before installing this product.
- To reduce the risk of fire or electrical shock, do NOT expose the product to rain, liquids, or moisture. Not applicable for products rated IPX4-9.
- Do NOT expose this product to dripping or splashing and do not place objects filled with liquids, such as vases, on or near the product. Not applicable to products rated IPX4-9.
- Keep the product away from fire and heat sources. Do NOT place naked flame sources, such as lighted candles, on or near the product.
- Do NOT use a power inverter with this product.
- Do NOT use in vehicles or boats.
- Do NOT make unauthorized alterations to this product.
- Do NOT expose products containing batteries to excessive heat (e.g. from storage in direct sunlight, fire, or the like).
- The battery accessory provided with this product may present a risk of fire or chemical burn if mishandled.
- Where the mains plug or appliance coupler is used as the disconnect device, the disconnect device shall remain readily operable.
- Only use genuine Bose batteries with this product. Contact Bose customer service for replacement batteries.
- Do NOT use the Bose S1 Pro system with a tripod/stand that is unstable. The loudspeaker is only designed for use on a 35 mm post, and the tripod/stand must be capable of supporting a speaker with a minimum weight of 7 kg (15 lbs) and an overall size of 241 x 279 x 330 mm (9.5 x 11 x 13 inches). Using a tripod/stand that is not designed to support the size and mass of the S1 Pro system may lead to an unstable and hazardous condition that could result in injury.

Charging temperature range: 0°C - 42°C (32°F - 108°F)
Discharging temperature range: -20°C - 45°C (-4°F - 113°F)

Regulatory Information

This device complies with part 15 of the FCC Rules and with Industry Canada license-exempt RSS standard(s). Operation is subject to the following two conditions: (1) This device may not cause harmful interference, and (2) this device must accept any interference received, including interference that may cause undesired operation.

 Bose Corporation hereby declares that this product is in compliance with the essential requirements and other relevant provisions of Directive 2014/53/EU and all other applicable EU directive requirements. The complete declaration of conformity can be found at: www.Bose.com/compliance.

Frequency band of operation 2402 to 2480 MHz.
Bluetooth: Maximum transmit power less than 20 dBm EIRP.
Bluetooth Low Energy: Maximum power spectral density less than 10 dBm/MHz EIRP.

This product meets all EN55103-2 immunity requirements for E2 electromagnetic environment.

This equipment should be installed and operated with a minimum distance of 20 cm between radiator and your body

Shielded cables are required to maintain regulatory compliance

Changes or modifications not expressly approved by Bose Corporation could void the user's authority to operate this equipment.

Information About Products That Generate Electrical Noise (FCC Compliance Notice for US)

Note: This equipment has been tested and found to comply with the limits for a Class A digital device, pursuant to part 15 of the FCC Rules. These limits are designed to provide reasonable protection against harmful interference when the equipment is operated in a commercial environment. This equipment generates, uses, and can radiate radio frequency energy and, if not installed and used in accordance with the instruction manual, may cause harmful interference to radio communications. Operation of this equipment in a residential area is likely to cause harmful interference in which case the user will be required to correct the interference at one's own expense.

Management Regulation for Low-power Radio-frequency Devices

Article XII

According to "Management Regulation for Low-power Radio-frequency Devices", without permission by the NCC, any company, enterprise, or user is not allowed to change frequency, enhance transmitting power, or alter original characteristics, as well as performance, to an approved low power radio-frequency device.

Article XIV

The low power radio-frequency devices shall not influence aircraft security and interfere with legal communications; if found, the user shall cease operating immediately until no interference is achieved. The said legal communications means radio communications in compliance with the Telecommunications Act.

The low power radio-frequency devices must be susceptible with the interference from legal communications or ISM radio wave radiated devices.

For Denmark, Finland, Norway, and Sweden:

English: Provide an earth connection or ensure the socket outlet incorporates a protective earthing connection before connecting the plug to the mains socket outlet.

Danish: Apparatets stikprop skal tilsluttes en stikkontakt med jord, som giver forbindelse til stikproppens jord.

Finnish: Laite on liitettävä suojamaadoituskoskettimilla varustettuun pistorasiaan.

Norwegian: Apparatet må tilkoples jordet stikkontakt.

Swedish: Apparatens skall anslutas till jordat uttag.

Names and Contents of Toxic or Hazardous Substances and Elements

Part Name	Toxic or Hazardous Substances and Elements					
	Lead (Pb)	Mercury (Hg)	Cadmium (Cd)	Hexavalent (CR(VI))	Polybrominated Biphenyl (PBB)	Polybrominated diphenylether (PBDE)
PCBs	X	0	0	0	0	0
Metal parts	X	0	0	0	0	0
Plastic parts	0	0	0	0	0	0
Speakers	X	0	0	0	0	0
Cables	X	0	0	0	0	0

This table is prepared in accordance with the provisions of SJ/T 11364.
0: Indicates that this toxic or hazardous substance contained in all of the homogenous materials for this part is below the limit requirement of GB/T 26572.
X: Indicates that this toxic or hazardous substance contained in at least one of the homogenous materials used for this part is above the limit requirement of GB/T 26572.

 This symbol means the product must not be discarded as household waste, and should be delivered to an appropriate collection facility for recycling. Proper disposal and recycling helps protect natural resources, human health, and the environment. For more information on disposal and recycling of this product, contact your local municipality, disposal service, or the shop where you bought this product.

 Please dispose of used batteries properly, following local regulations. Do not incinerate.



Li-ion



Provided by DCE Safety

Introduction

Quick Setup Guide.....	4
Welcome	5
Product Overview	5
Features and Benefits.....	5
Accessories	5
In-Box Accessories	5
Optional Accessories.....	5
System Configurations	6
Elevated Surface.....	6
Tilt-Back.....	6
Monitor	6
Speaker Stand	6

Operating Information

Connections and Controls	7
--------------------------------	---

System Setup

Connect Power	8
Connect Sources.....	8
Set Channel 1 & 2 Controls	8
Set Channel 3 Controls	9
Use a Speaker Stand	9
Connection Scenarios.....	10
Elevated Surface.....	10
Tilt-Back.....	11
Monitor	12
Speaker Stand	13
General Purpose PA	14

Care and Maintenance

Troubleshooting	16
Caring for Your Product.....	17
Cleaning.....	17
Bose® S1 Pro Specifications	17

Additional Information

Contact Information	18
Importer Information	18
Limited Warranty and Registration.....	18
Additional Information	18
Date of Manufacture	18

Introduction

Quick Setup Guide

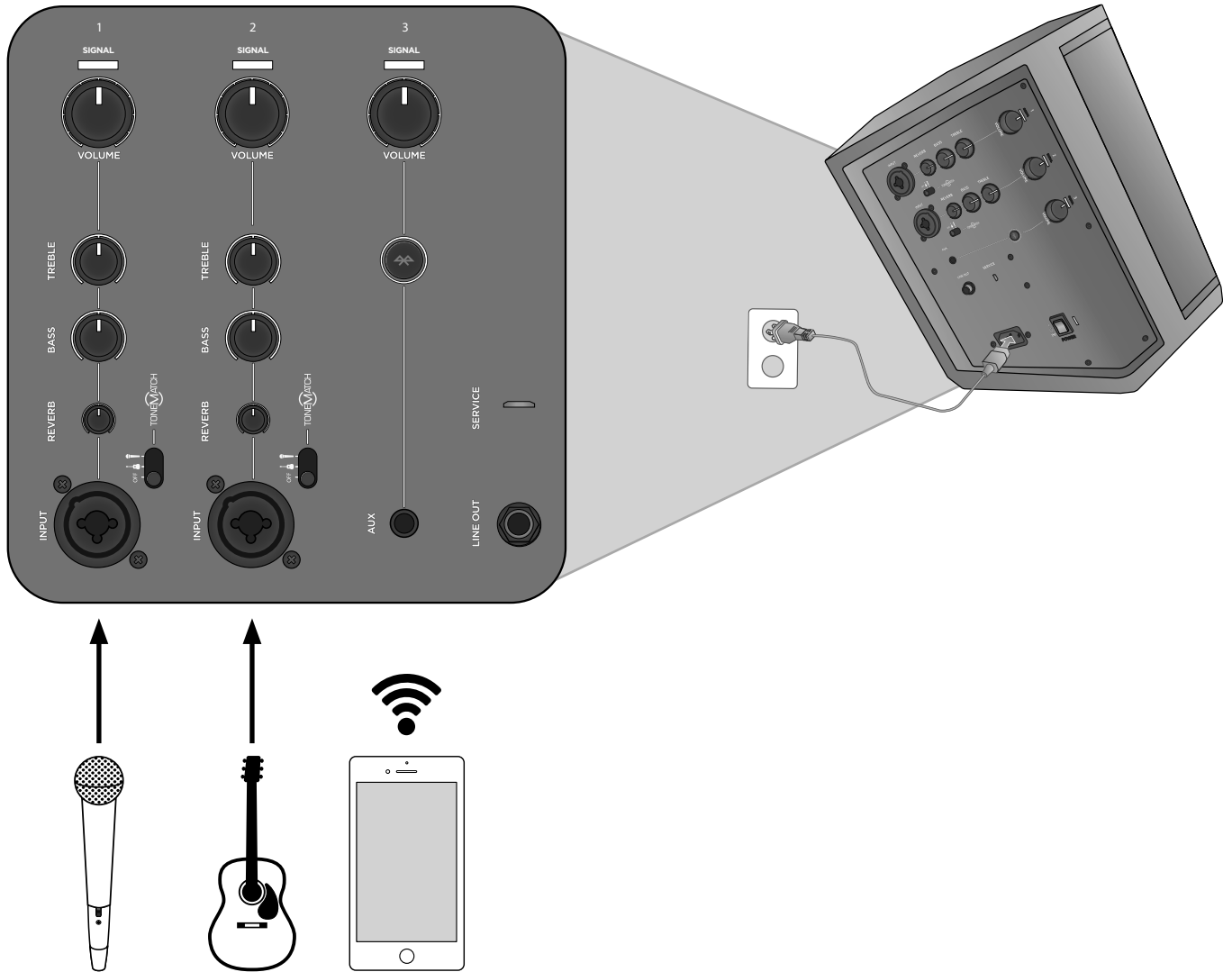

Note: For use of the Bose® S1 Pro Multi-Position PA system with an optional rechargeable battery (not included), see the battery accessory owner's guide on www.Bose.com.

Please complete and retain for your records.

Serial number: _____

Model number: _____

Welcome

Thank you for purchasing the Bose® S1 Pro Multi-Position PA system. Whether you are performing for a small audience, hosting your own special event or entertaining at home, now you'll always be ready to sound great.

This guide provides detailed setup and operating instructions for your S1 Pro system and explains how to connect to a variety of audio sources. For additional information on using the system, including tips, techniques and frequently asked questions, please visit www.Bose.com/livesound.

Product Overview

Sound great anywhere with the ultra-portable Bose S1 Pro Multi-Position PA system. Designed for musicians, DJs and general PA use, the S1 Pro is the ultimate all-in-one PA, floor monitor, practice amplifier and primary music system.

Multiple positions with Auto EQ allow the S1 Pro to be set down on the floor, up on a table or even mounted on a tripod stand, ensuring that you always sound your best. And with a 3-channel mixer, reverb, *Bluetooth*® streaming and ToneMatch® processing onboard, it's always ready to become your go-anywhere music system for nearly any occasion.

Features and Benefits

- **Lightweight & Portable** – Weighing about 15 lbs (6.8 kg), the rugged S1 Pro is designed to transport effortlessly from the car to the event.
- **Versatility meets Simplicity** – The S1 Pro comes with a full-featured, 3-channel mixer with reverb and *Bluetooth* streaming. Sound great quickly with ToneMatch® processing for microphones and acoustic guitars, while playing music wirelessly using your mobile device. Perform nearly anywhere with the optional rechargeable Li-ion battery for the ultimate portability.
- **Adaptable** – Multiple positions give you the best coverage options for your application, while Auto EQ maintains optimum sound in any orientation.
- **Impressive size-to-performance ratio** – The S1 Pro delivers high-output in a small package, ready to serve as your ultimate all-in-one PA, floor monitor, practice amplifier or primary music system.

Accessories

In-Box Accessories

The S1 Pro carton contains an S1 Pro system and one each of the following accessories:

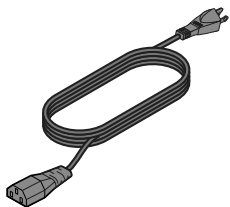

AC power cord

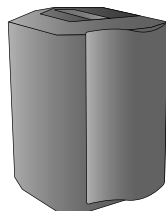

Cover

Optional Accessories

- Battery
- Backpack
- Colored Slip Cover

For a complete list of optional equipment and accessories, please visit www.Bose.com.

Introduction

System Configurations

The versatile Bose® S1 Pro Multi-Position PA system operates in four unique modes. With Auto EQ, the system automatically updates to maintain optimum tonal balance for each coverage pattern. Use the examples below to quickly identify the best mode for your application.

Elevated Surface

Position the S1 Pro on a surface. This projects sound clearly and evenly throughout the audience, and ensures that audience members enjoy the full frequency range of the system.

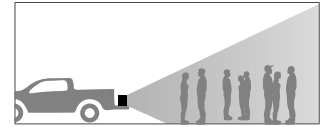
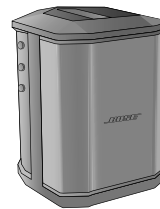

Tilt-Back

For performances where your audience is close to you, tilt the S1 Pro onto its back edge. For best results, the performer should stand or sit to one side of the loudspeaker to avoid blocking sound from the audience.

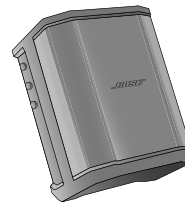

Monitor

To use the S1 Pro as a personal floor monitor, place it on the ground horizontally, in front of and pointing toward the performer. Tilt the loudspeaker onto its side edge.

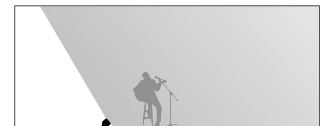
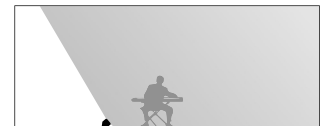
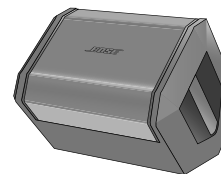

Speaker Stand

Place one or two S1 Pro systems on speaker stands (sold separately) for general-purpose sound reinforcement.

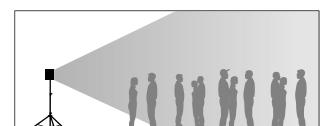
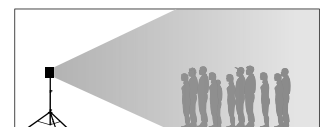

Note: Rotate the Bose logo counterclockwise to match your chosen mode.

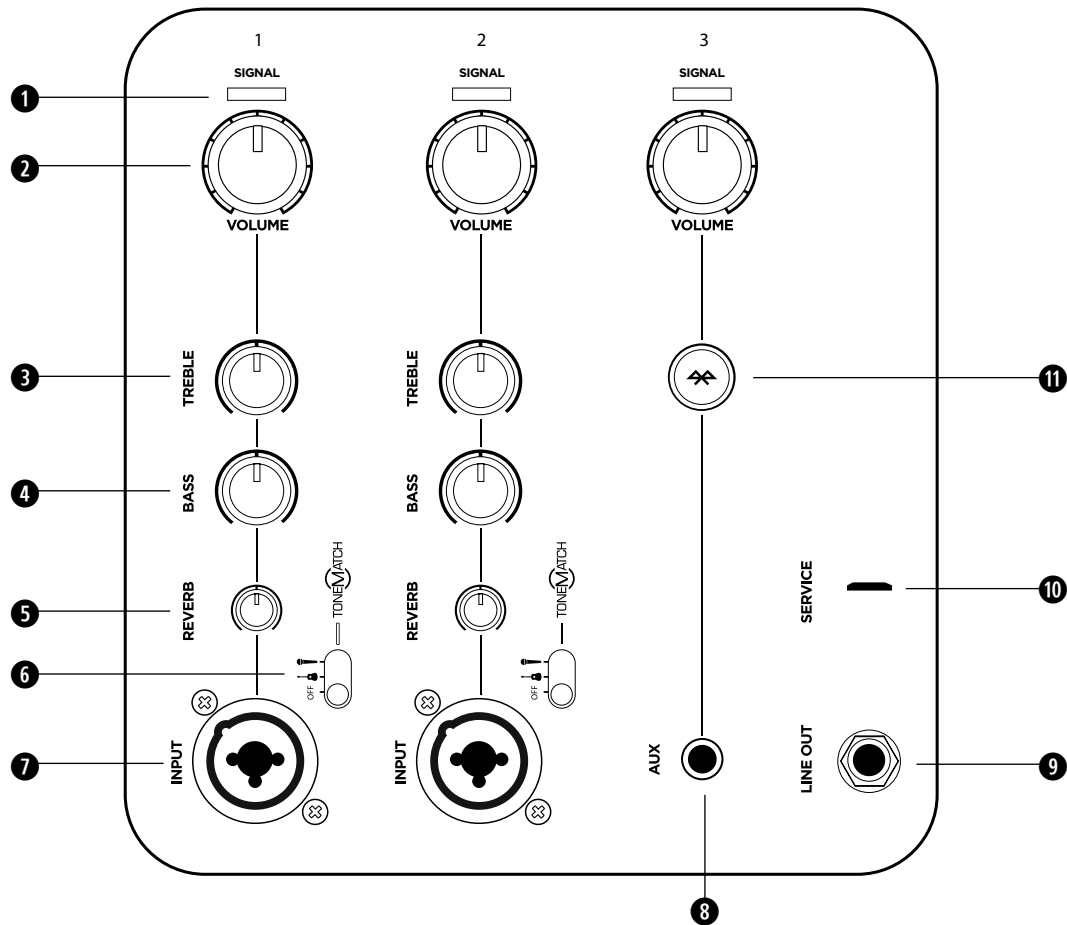

Connections and Controls

The Bose® S1 Pro control panel provides the necessary connectors, controls and indicators for operation.



Use Channel 1 and 2 inputs for microphones and musical instruments. Integrated ToneMatch® signal processing allows microphones and instruments to sound their best. Use Channel 3 for Bluetooth® connectivity and line-level inputs.

- 1 SIGNAL/CLIP INDICATOR** - Displays the input signal status in color.
 - Green: Signal present
 - Red: Signal clipping

Note: Reduce the corresponding volume control to prevent steady red operation.
- 2 VOLUME CONTROL** - Adjust the volume of your microphone, instrument or audio source.
- 3 TREBLE CONTROL** - Adjust the high-frequency balance of your microphone or instrument.
- 4 BASS CONTROL** - Adjust the low-frequency balance of your microphone or instrument.
- 5 REVERB CONTROL** - Adjust the amount of reverb applied to your microphone or instrument.
- 6 TONEMATCH SWITCH** - Move the switch to the  or  position to enable the ToneMatch preset.
- 7 SIGNAL INPUT** - Analog input for connecting microphone (XLR) and instrument (TS unbalanced) cables.
- 8 AUX INPUT** - Use a 3.5 mm TRS cable to connect a line-level audio source. *Note: This input is muted when Bluetooth connectivity is active.*
- 9 LINE OUTPUT** - Use a 1/4" TRS cable to connect the line-level output to the Aux Input of a second S1 Pro, to create a mono two-loudspeaker setup. *Note: Line Out is post mix.*
- 10 SERVICE PORT** - Micro-USB connector for Bose service use only.
- 11 BLUETOOTH PAIR BUTTON** - Used to set up pairing with Bluetooth-capable devices, such as mobile phones, tablets, and laptops (see "Bluetooth Pairing" on page 9).

System Setup

Connect Power

1. Make sure the power switch is in **Standby** (⏻).
2. Plug one end of the power cord into the connector on the S1 Pro.
3. Plug the other end of the power cord into a live electrical outlet.
4. Connect sound sources before turning the system on. See “Connect Sources” below.
5. Once the sound sources are connected, turn the system on by moving the power switch to **On** (I).

Note: The **Quick Charge** (⚡) power setting is for use with the battery accessory only. For more information, see the battery accessory owner’s guide, available at www.Bose.com.

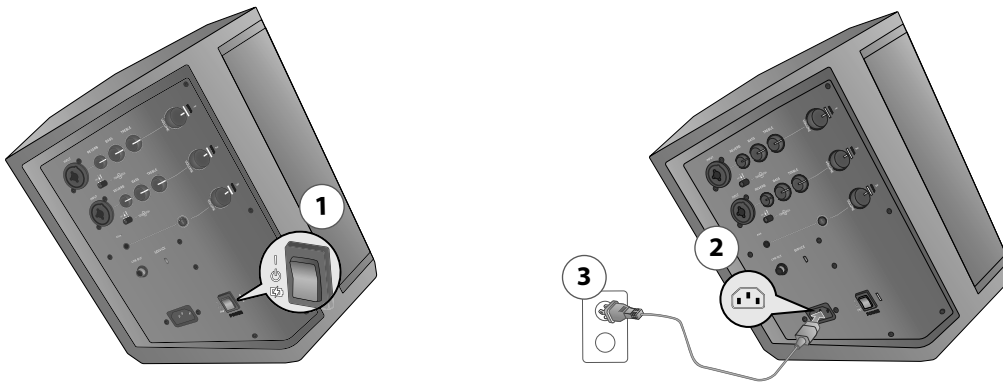



Connect Sources

Before plugging in a sound source, adjust all channel **Volume** controls fully counterclockwise.

Set Channel 1 & 2 Controls



Channel 1 and 2 are for use with dynamic microphones, guitars, keyboards or other instruments.

1. Before connecting your microphone or instrument, adjust the **Volume** control for the appropriate channel fully counterclockwise.
2. Channels 1 and 2 are equipped with an integrated ToneMatch® preset to automatically optimize the sound of your microphone or instrument. If desired, apply the ToneMatch preset by moving the ToneMatch switch for the appropriate channel to  for microphones or  for other instruments.
3. While speaking into the microphone or playing your instrument, adjust the volume to the desired level by slowly turning the **Volume** control clockwise.
4. Adjust the **Treble**, **Bass**, and **Reverb** controls to make further refinements based on your personal preference. While speaking into the microphone or playing your instrument, slowly adjust the control until desired effect is achieved.

Set Channel 3 Controls

Channel 3 is for use with *Bluetooth*®-capable devices and line-level audio inputs.

Bluetooth Pairing

1. On your device, turn on the *Bluetooth* feature. **Note:** *The Bluetooth feature is usually in the Settings menu.*
2. Press and hold the  button for two seconds. Select your Bose® S1 Pro from the device list. While the device is pairing, the  flashes white. When the device pairs successfully, the  will turn solid white. **Note:** *If pairing is unsuccessful, repeat steps 1 and 2 until the devices are synced.*
3. Press play and turn up the **Volume** on the S1 Pro until indicator light is green, or the desired volume level is reached. If the volume indicator steadily glows red, decrease the volume.

Bluetooth Behaviors

- The most recently paired *Bluetooth* device will automatically sync when the S1 Pro is turned on.
- The S1 Pro can only be paired with one device at a time; to pair to a new device, repeat "*Bluetooth* Pairing".
- If your paired phone receives a call, any music playing will be paused and the ring will come through the phone; no calls or notifications will come through the S1 Pro.

AUX Input

1. Connect a 3.5 mm ($\frac{1}{8}$ ") cable to a line-level sound source. Make sure that the volume is turned up on the sound source. **Note:** *Anything connected via the AUX input will automatically override any device paired via Bluetooth connectivity.*
2. Turn up the **Volume** on the S1 Pro until the indicator light is green, or the desired volume level is reached. If the volume indicator steadily glows red, decrease the volume.

Using a Speaker Stand

The bottom of the S1 Pro system includes a pole cup for mounting the loudspeaker on a speaker stand. The pole cup fits a standard 35 mm post. When the S1 Pro is placed on a speaker stand, the EQ automatically updates to maintain optimum tonal balance.

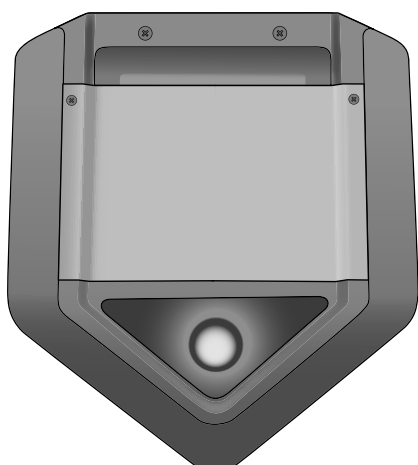

WARNING: Do NOT use the Bose S1 Pro system with a tripod/stand that is unstable. The loudspeaker is only designed for use on a 35 mm post, and the tripod/stand must be capable of supporting a speaker with a minimum weight of 7 kg (15 lbs) and an overall size of 241 x 279 x 330 mm (9.5 x 11 x 13 inches). Using a tripod/stand that is not designed to support the size and mass of the S1 Pro system may lead to an unstable and hazardous condition that could result in injury.

System Setup

Connection Scenarios

There are four primary ways to use the S1 Pro. The following pages show examples of typical setup scenarios.

Elevated Surface

Place the S1 Pro on a tabletop in the front of a room to give a business presentation or place it in the bed of your pickup truck for a tailgate party. Plug in a microphone and narrate over a multimedia presentation or get your friends pumped up before the game while listening to music wirelessly via your *Bluetooth*®-capable mobile device.

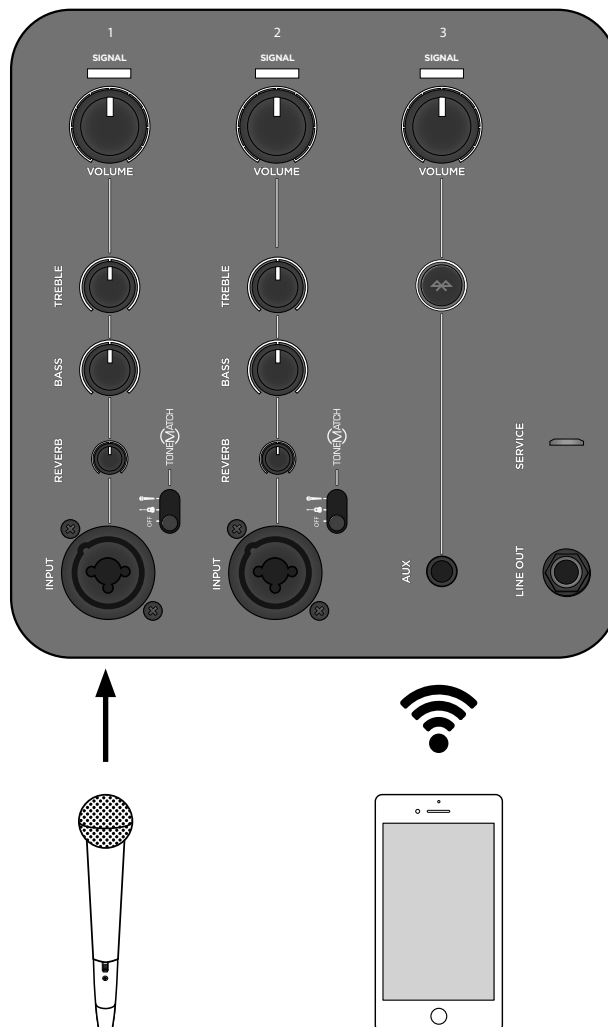
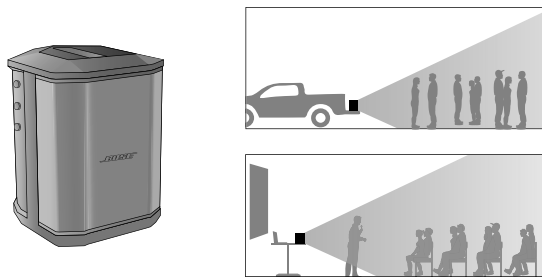

Tilt-Back

Place the S1 Pro in Tilt-Back position on the ground behind you for live musical performances. Tilting the loudspeaker onto its back edge creates a higher vertical coverage pattern, perfect for small audiences and passersby. Cue your backing tracks via *Bluetooth*® streaming and play along with a microphone and guitar.

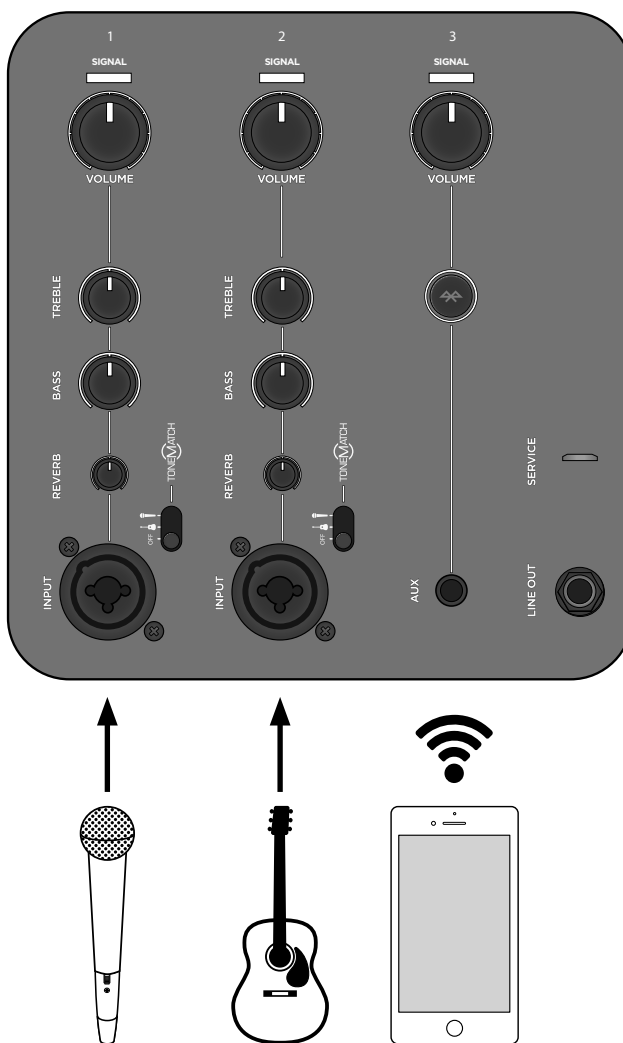
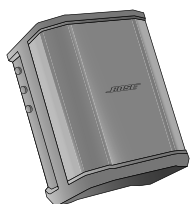

System Setup

Monitor

Place the S1 Pro on its horizontal side edge to use as a floor monitor. Face it toward the performer to be used as a personal monitor or send your mix to a main PA system, then dial in your equalization and reverb preferences for your performance.

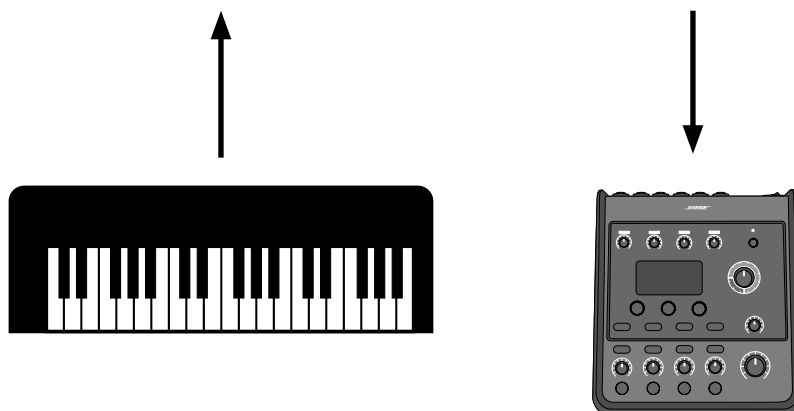
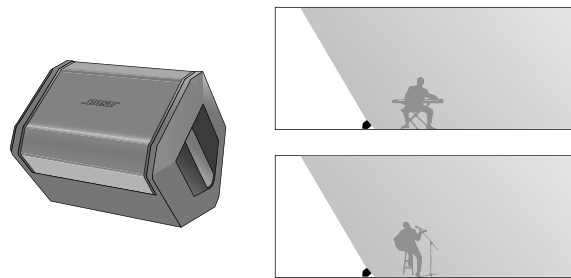

Speaker Stand

Using a conventional speaker stand, you can use your S1 Pro as a PA system. Connect a microphone and give a toast or sing a song while cuing the music wirelessly via *Bluetooth*® streaming. Use the line out to daisy-chain your S1 Pro into multiple units for more output and coverage.

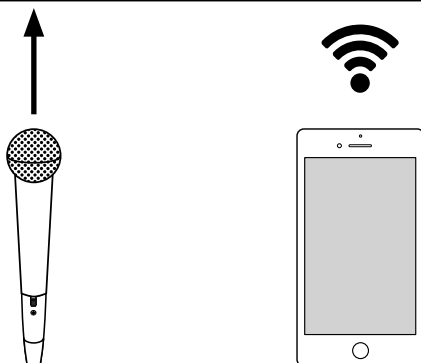
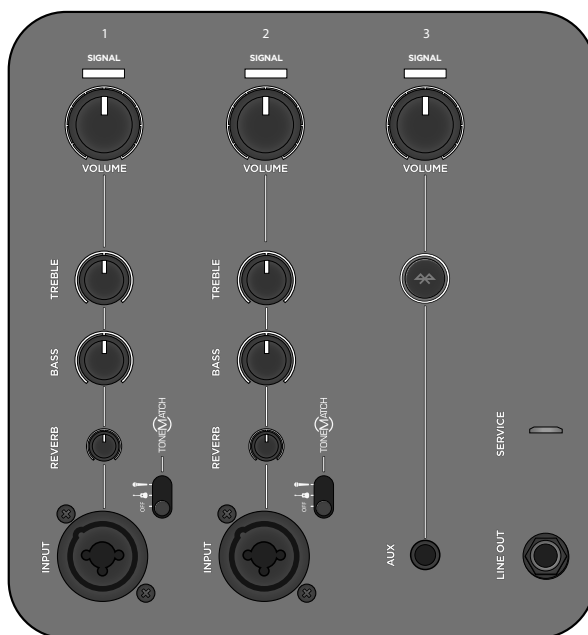
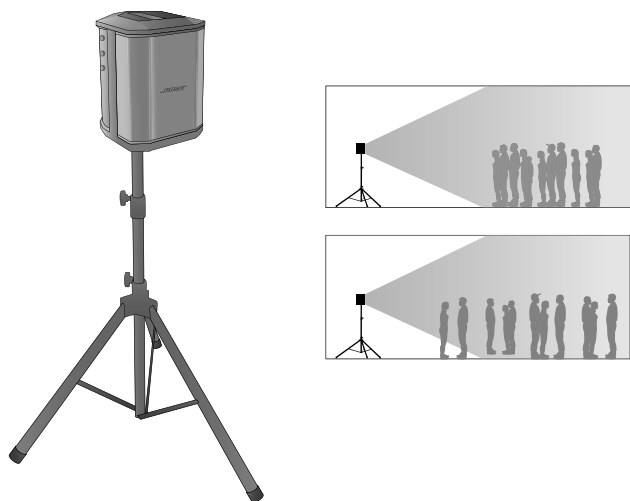

System Setup

General Purpose PA

Use a mixer with two S1 Pro systems as a conventional PA system. The wide and consistent coverage of the system ensures that the entire audience can easily hear the performance throughout the room.

Stereo

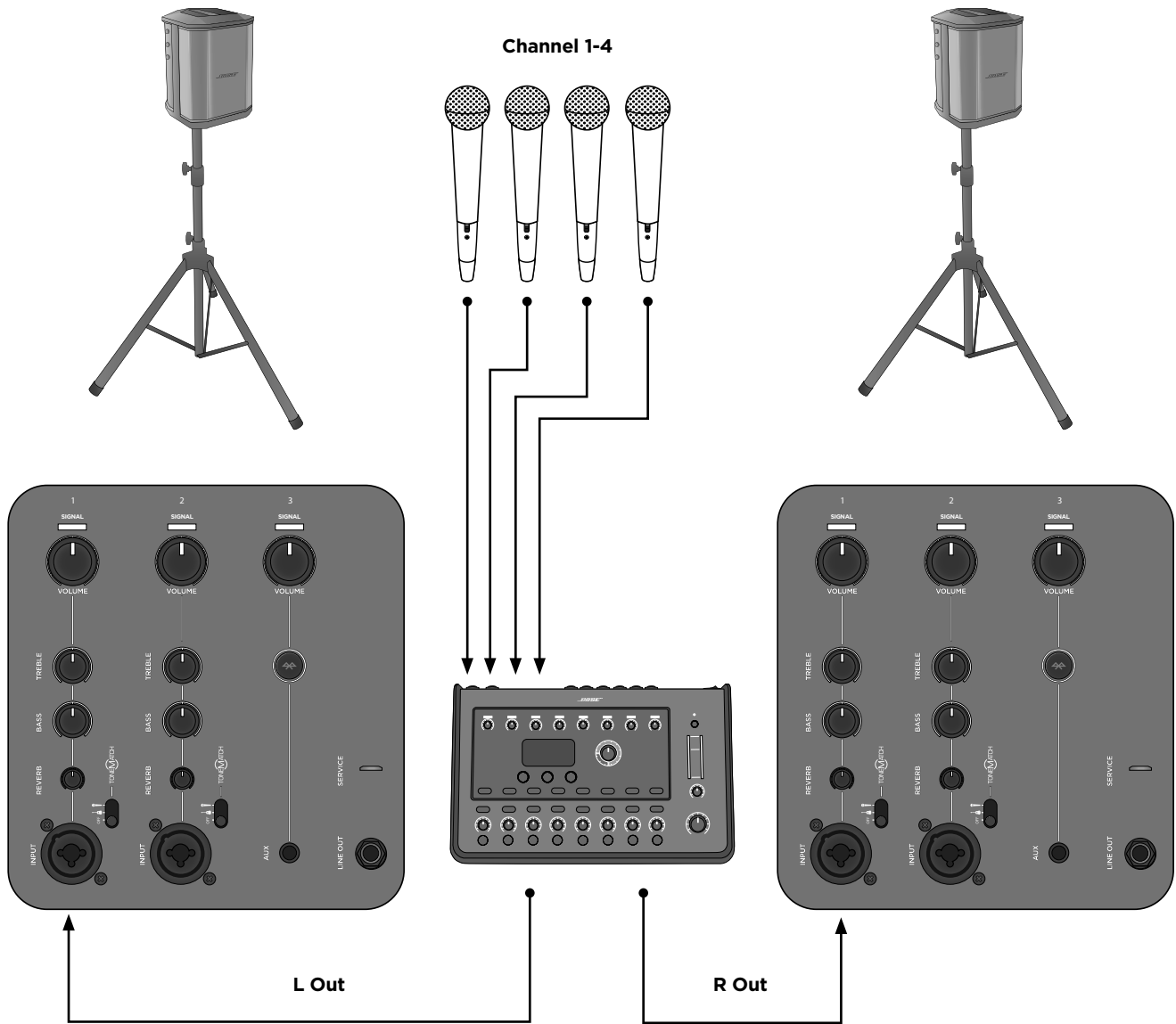

Note: When used as a conventional PA, reverb and ToneMatch® should be turned off.

Mono / Daisy-Chain

Link two S1 Pro systems together in mono by using a TRS ¼" cable. Take the line out of the primary unit and plug it into the secondary S1 Pro system. Turn the channel volume up until both units are at desired volume.

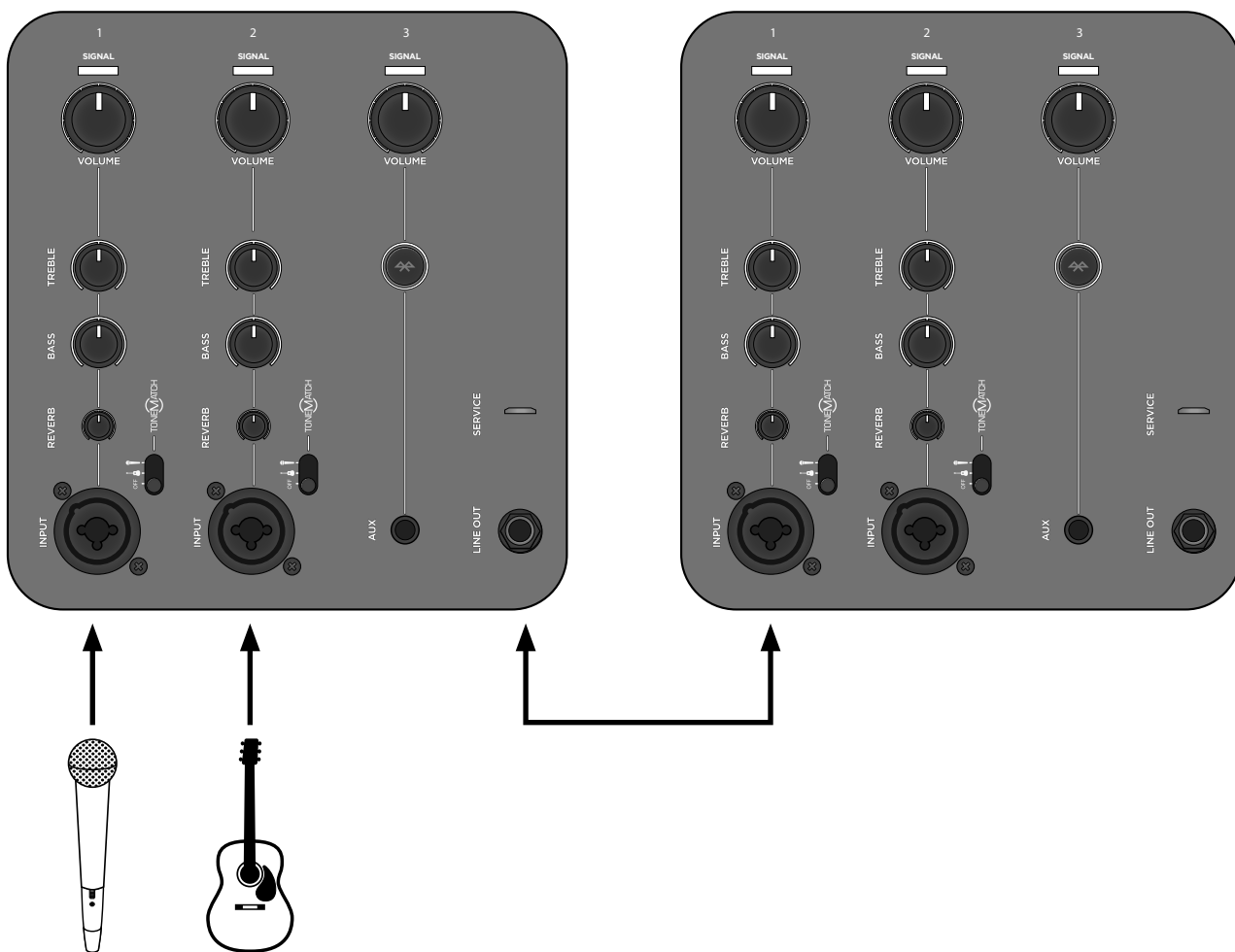
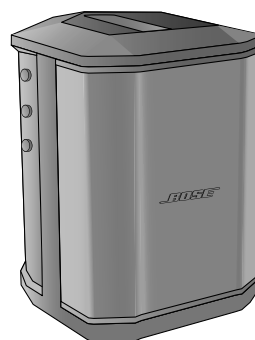
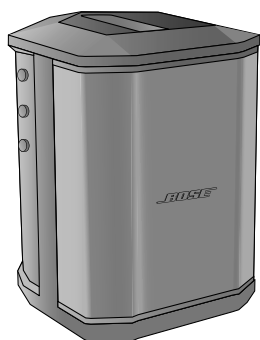

Note: On secondary units, set ToneMatch® and reverb to off and leave tone controls at center detent position.

Care and Maintenance

Troubleshooting

If you experience problems while using this product, try the following solutions. If you still cannot solve the problem, seek online help at www.Bose.com/livesound. If you cannot find answers to your questions there, please call the Bose Product and Technical Support Team directly at (877) 335-2673.

Problem	What to do
System is plugged in, power switch is on, but power LED is off	<ul style="list-style-type: none">• Make sure you have power at the AC outlet. Try operating a lamp or other equipment from the same AC outlet or test the outlet using an AC outlet tester.
Power LED is on (blue), but no sound	<ul style="list-style-type: none">• Make sure your instrument is plugged into the signal input.• Make sure the volume control is turned up on your source.• Make sure the volume control is turned up on the S1 Pro.• Make sure your Signal/Clip indicator is lit.• Plug your instrument into a different amplifier to make sure the source is working.
Power LED is red	<ul style="list-style-type: none">• Please call Product and Technical Support at (877) 335-2673.
With nothing plugged into the S1 Pro, a slight hum or buzz is heard	<ul style="list-style-type: none">• Using an AC outlet tester, test the AC outlet the S1 Pro is plugged into for reversed or open (hot, neutral, and/or ground) contacts.• If using an extension cord, plug the S1 Pro directly into the outlet.
Instrument or audio source sounds distorted	<ul style="list-style-type: none">• Turn volume down on the source; if your audio source volume cannot be adjusted, "input pads" are available from your preferred instrument retailer.• Try a different source or instrument.
Microphone is encountering feedback	<ul style="list-style-type: none">• Turn volume down.• Orient the microphone so that it is not pointing directly at the loudspeaker.• Try a different microphone.• Try a different position for the loudspeaker and/or vocalist on stage.• Increase the distance from the loudspeaker to the microphone.• If using a vocal effects processor, make sure it is not contributing to the feedback problem.
Paired <i>Bluetooth</i> ® device will not connect to the speaker	<ul style="list-style-type: none">• If your device requires a passcode, make sure the one you entered is correct.• Make sure <i>Bluetooth</i> functionality is turned on or enabled on your source device.• Your <i>Bluetooth</i> device may be out of range; try moving it closer to the speaker.• If possible, turn off all other nearby <i>Bluetooth</i> devices or disable their <i>Bluetooth</i> functionality.• Clear the speaker memory or pair to new device by pressing and holding the <i>Bluetooth</i> button for ten seconds. Pair the <i>Bluetooth</i> device and the speaker again.• Turn the power off and back on; then try re-pairing your device.
Excessive hum when daisy-chaining multiple units	<ul style="list-style-type: none">• Make sure you're using a ¼" TRS cable; do not use a ¼" TS (guitar) cable.

Caring For Your Product

Cleaning

- Clean the product enclosure using only a soft, dry cloth.
- Do not use any solvents, chemicals, or cleaning solutions containing alcohol, ammonia, or abrasives.
- Do not use any sprays near the product or allow liquids to spill into any openings.
- If necessary, you may carefully vacuum the grille of the loudspeaker.

Bose® S1 Pro Specifications

Enclosure	
Enclosure Material	Polypropylene plastic
Finish	Textured plastic
Grille	Steel with black powder-coat
Dimensions (H x W x D) - mm	330 x 241 x 286
Dimensions (H x W x D) - inches	13 x 9.5 x 11.2
Net Weight	15 lbs (6.8 kg)

Additional Information

Contact Information

Visit us on the web at **Bose.com**.

Americas

(USA, Canada, Mexico, Central America, South America)
Bose Corporation
Framingham, MA 01701 USA
Corporate Center: 508-879-7330
Americas Professional Systems,
Technical Support: 800-994-2673

Australia

Bose Pty Limited
Unit 3/2 Holker Street
Newington NSW Australia
61 2 8737 9999

Belgium

Bose N.V. / S.A
Limesweg 2, 03700
Tongeren, Belgium
012-390800

China

Bose Electronics (Shanghai) Co Ltd
25F, L'Avenue
99 Xianxia Road
Shanghai, P.R.C. 200051 China
86 21 6010 3800

France

Bose S.A.S
26-28 avenue de Winchester
78100 St. Germain en Laye, France
01-30-61-63-63

Germany

Bose GmbH
Max-Planck Strasse 36D 61381
Friedrichsdorf, Deutschland
06172-7104-0

Hong Kong

Bose Limited
Suites 2101-2105, Tower One, Times Square
1 Matheson Street, Causeway Bay, Hong Kong
852 2123 9000

India

Bose Corporation India Private Limited
Salcon Aurum, 3rd Floor
Plot No. 4, Jasola District Centre
New Delhi - 110025, India
91 11 43080200

Italy

Bose SpA
Centro Leoni A - Via G. Spadolini
5 20122 Milano, Italy
39-02-36704500

Japan

Bose Kabushiki Kaisha
Sumitomo Fudosan Shibuya Garden Tower 5F
16-17, Nanpeidai-cho
Shibuya-Ku, Tokyo, 150-0036, Japan
TEL 81-3-5489-0955
www.bose.co.jp

The Netherlands

Bose BV
Gorslaan 60
1441 RG Purmerend
The Netherlands
0299-390139

United Kingdom

Bose Ltd
1 Ambley Green, Gillingham Business Park
KENT ME8 0NJ
Gillingham, England
0870-741-4500

See website for other countries

Importer Information

European Union

Bose Products B.V., Gorslaan 60, 1441 RG
Purmerend, The Netherlands

China

Bose Electronics (Shanghai) Company
Limited, Part C, Plan 9, No. 353 North
Riying Road, China (Shanghai) Pilot Free
Trade Zone

Taiwan

Bose Taiwan Branch, 9F-A1, No. 10, Section
3, Minsheng East Road, Taipei City 104,
Taiwan
Tel: +886-2-2514 7676

Mexico

Bose de México, S. de R.L. de C.V., Paseo
de las Palmas 405-204, Lomas de Cha-
pultepec, 11000 México, D.F.
Tel: +5255 (5202) 3545

Limited Warranty and Registration

Your speaker is covered by a limited warranty. Visit our website at **pro.Bose.com** for details of the limited warranty.

The warranty information provided with this product does not apply in Australia and New Zealand. See our website at **www.bose.com/au/warranty** or **www.bose.com/nz/warranty** for details of the Australian and New Zealand warranty.

The Bose® S1 Pro is covered by patents issued or pending in the U.S. and other countries.

Additional Information

To request a printed copy of this owner's guide, use the phone numbers provided.

The *Bluetooth*® word mark and logos are registered trademarks owned by Bluetooth SIG, Inc. and any use of such marks by Bose Corporation is under license.

Date of Manufacture

The eighth digit in the serial number indicates the year of manufacture; "6" is 2006 or 2016.



807173-0010

©2017 Bose Corporation, All rights reserved.
Framingham, MA 01701-9168 USA
www.Bose.com
All trademarks are the property of their respective owners
AM807173 Rev. 00
September 2017

